

Vergleich – Comparison - Comparaison OLOID 200 – 400 – 600

SYSTEMSCHATZ

OLOID Typ 200 K OLOID Typ 400 K OLOID Typ 600

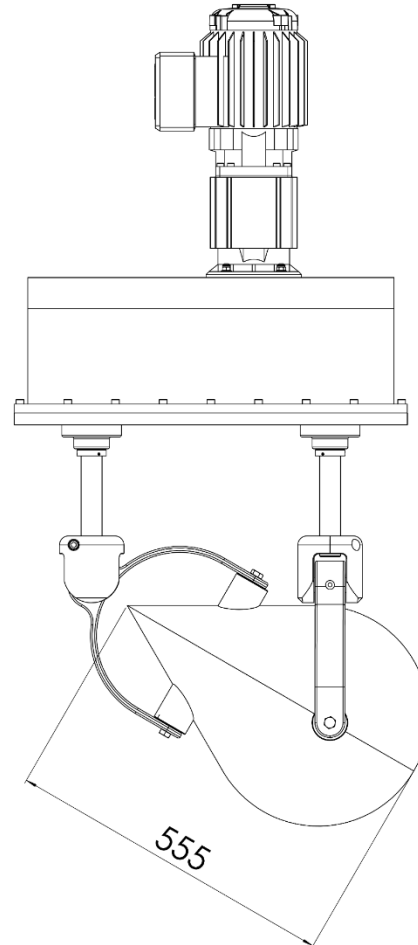
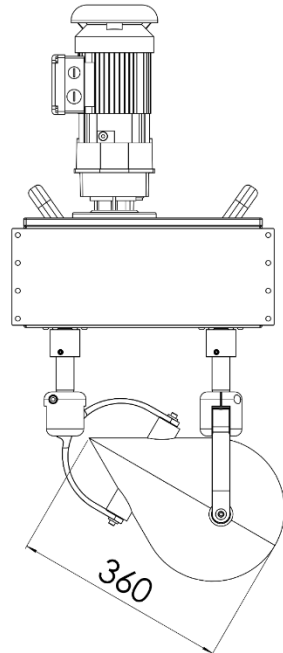
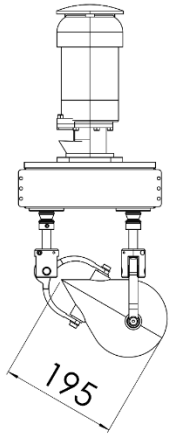

RÜHREN
UMWÄLZEN
BELÜFTEN

AGITATE
CIRCULATE
AERATE

AGITER
BRASSER
AERER

Der etwas andere Umgang
mit dem Wasser

The new approach to water

L'OLOÏDE: la manière de
traiter l'eau avec respect

Produkte und weitere Informationen bei
Products and further information at
Produits et informations chez



Inversions-Technik GmbH
Jurastrasse 50, CH-4053 Basel
Tel. +41 (0)61 361 21 11
www.oid.ch, mail@oid.ch

DEUTSCH	OLOID TYP 200 DATEN	OLOID TYP 400 DATEN	OLOID TYP 600 DATEN
Ausführungen	200 K DC 24 V 200 K AC 230/400 V 200 K Solar 24 V	400 K DC 24 V 400 K AC 230/400 V 400 K AC-T 230/400 V 400 K Solar 24 V	600 I 600 T
Mechanische und elektrische Daten	Für 200 K AC bei 125 U/Min:	Für 400 K AC bei 55 U/Min:	bei 50 U/Min:
OLOID-Körper	195 mm, Edelstahl 1.4301	360 mm, V4A Edelstahl 1.4571	555 mm, V4A Edelstahl 1.4571
Nennleistung	120 W	250 W	750 W
Nettleistungsaufnahme (abhängig von Drehzahl & Eintauchtiefe)	120 W (Umwälzstellung)	200 W (Umwälzstellung)	450 W (Umwälzstellung)
Gewicht	12,5 kg	48 kg	108 kg
Umwälz- und Belüftungsleistung	gemessen bei 125 U/Min:	gemessen bei 55 U/Min:	gemessen bei 50 U/Min:
Strömung	30 m weit, 3 m tief	100 m weit, 3 – 6 m tief	200 m weit, 3 – 6 m tief
Förderleistung	n.v. m ³ /h	700 m ³ /h	1400 m ³ /h
Anwendungsvolumina in See, Teich & Gartenbau in Teichkläranlagen in Güllebehandlung in Belebtschlamm	bis zu 1.000 m ³ nicht im Einsatz nicht im Einsatz nicht im Einsatz	bis zu 10.000 m ³ ca. 2.000-3.000 m ³ ca. 400 m ³ ca. 100 m ³	bis zu 25.000 m ³ ca. 5.000-7.000 m ³ ca. 1.500 m ³ ca. 500 m ³
Sauerstoffeintrag	bis 50 gO ₂ /h	bis 250 gO ₂ /h	n.v. gO ₂ /h
Sauerstoffertag	bis 1,65 kgO ₂ /kWh	bis 1,25 kgO ₂ /kWh	n.v. kgO ₂ /kWh

Änderungen der technischen Daten bleiben vorbehalten.

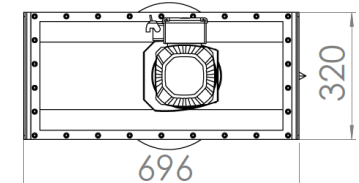
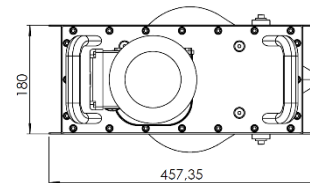
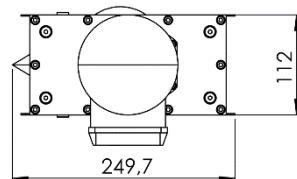

ENGLISH	OLOID TYPE 200 SPECIFICATIONS	OLOID TYPE 400 SPECIFICATIONS	OLOID TYPE 600 SPECIFICATIONS
Models	200 K DC 24 V 200 K AC 230/400 V 200 K Solar 24 V	400 K DC 24 V 400 K AC 230/400 V 400 K AC-T 230/400 V 400 K Solar 24 V	600 I 600 T
Mechanical and Electrical Data	For 200 K AC at 125 rpm:	For 400 K AC at 55 rpm:	At 50 rpm:
OLOID-Body	195 mm, stainless steel 1.4301	360 mm, V4A stainless steel 1.4571	555 mm, V4A stainless steel 1.4571
Rated Capacity	120 W	250 W	750 W
Net Power Consumption (depending on speed an immersion depth)	120 W (Agitator position)	200 W (Agitator position)	450 W (Agitator position)
Weight	12.5 kg	48 kg	108 kg
Agitation and Aeration Capacity	Measured at 125 rpm:	Measured at 55 rpm:	Measured at 50 rpm:
Flow	30 m horizontally, 3 m vertically	100 m horizontally, 3 – 6 m vertically	200 m horizontally, 3 – 6 m vertically
Output	n.a. m ³ /h	700 m ³ /h	1400 m ³ /h
Application Volumes in Lake, Pond, Horticulture in Pond Treatment Plants in Manure Treatment in Activated Sludge	Up to 1.000 m ³ Not in use Not in use Not in use	Up to 10.000 m ³ approx. 2.000-3.000 m ³ approx. 400 m ³ approx. 100 m ³	Up to 25.000 m ³ approx. 5.000-7.000 m ³ approx. 1.500 m ³ approx. 500 m ³
Oxygenation	Up to 50 gO ₂ /h	Up to 250 gO ₂ /h	n.a. gO ₂ /h
Oxygen Transfer Efficiency	Up to 1,65 kgO ₂ /kWh	Up to 1,25 kgO ₂ /kWh	n.a. kgO ₂ /kWh

Specifications are subject to change without notice.

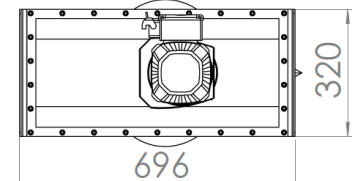
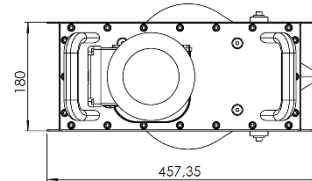
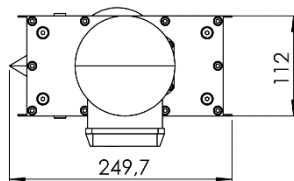

FRANCAIS	OLOIDE TYPE 200 DONNÉES	OLOIDE TYPE 400 DONNÉES	OLOIDE TYPE 600 DONNÉES
Modèles	200 K DC 24 V 200 K AC 230/400 V 200 K Solaire 24 V	400 K DC 24 V 400 K AC 230/400 V 400 K AC-T 230/400 V 400 K Solaire 24 V	600 I 600 T
Caractéristiques techniques	Pour 200 K AC à 125 tr/min:	Pour 400 K AC à 55 tr/min:	à 50 tr/min:
Corps de l'OLOÏDE	195 mm, acier inox 1.4301	360 mm, acier inox V4A 1.4571	555 mm, acier inox V4A 1.4571
Puissance nominale	120 W	250 W	750 W
Puissance absorbée (dépend de la vitesse de rotation et de la profondeur d'immersion)	120 W (en position agitateur)	200 W (en position agitateur)	450 W (en position agitateur)
Poids	12,5 kg	48 kg	108 kg
Performances d'agitation et d'aération	Mesurées à 125 tr/min:	Mesurées à 55 tr/min:	Mesurées à 50 tr/min:
Courant induit	30 m horizontalement, 3 m verticalement	100 m horizontalement, 3 – 6 m verticalement	200 m horizontalement, 3 – 6 m verticalement
Débit	non annoncé m ³ /h	700 m ³ /h	1400 m ³ /h
Volumes des bassins et applications : Lacs, étangs, horticulture Lagunes Traitement du fumier/lisier Boues activées	Jusqu'à 1.000 m ³ Non préconisé Non préconisé Non préconisé	Jusqu'à 10.000 m ³ environ 2.000-3.000 m ³ environ 400 m ³ environ 100 m ³	Jusqu'à 25.000 m ³ environ 5.000-7.000 m ³ environ 1.500 m ³ environ 500 m ³
Transfert d'oxygène	Jusqu'à 50 gO ₂ /h	Jusqu'à 250 gO ₂ /h	non annoncé gO ₂ /h
Rendement d'oxygène	Jusqu'à 1,65 kgO ₂ /kWh	Jusqu'à 1,25 kgO ₂ /kWh	non annoncé kgO ₂ /kWh

Les données techniques sont susceptibles d'être modifiées à tout moment.

